

## IZT RecPlay

### Record & Replay System for RF Signals

- Frequency range 9 kHz to 3000 MHz
- Excellent RF performance
- Extremely low RF emission
- Many hours of continuous record & replay
- Up to eight diversity or multi-frequency channels
- Diversity & multi-frequency setup
- Ideal for MIMO system testing
- Real-time impairment simulation
- Powerful off-line post processing
- RF synchronous GPS NMEA map visualization, video camera & audio capture



Innovationszentrum  Telekommunikations-  
technik GmbH

# IZT RecPlay

## Record & Replay System for RF Signals

IZT RecPlay provides the perfect platform for RF receiver design validation of analog and digital radio, broadcast standards and telecommunication systems. It includes a state-of-the-art wideband recorder with integrated high-performance RF receiver, an external server for data streaming and a revolutionary signal generator, which combines 31 virtual signal generators in one platform.

With a real-time bandwidth of up to 24 MHz and a frequency range of 9 kHz to 3, 6 or 18 GHz, the recorder covers the whole FM broadcast band simultaneously. An unmatched bandwidth of 120 MHz allows the replay generator to combine multiple recorded and calculated scenarios.

IZT's innovative high-performance record & replay system for high-quality RF signals offers customers greatly reduced costs for field-testing, repeatable lab tests, fidelity in reproducing real RF environment and shorter time to market.

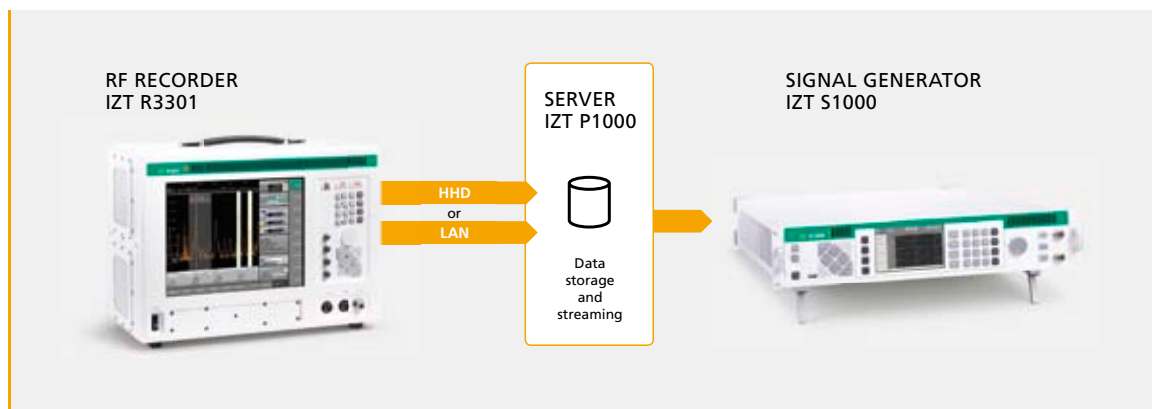

figure 1: Example of an one channel IZT RecPlay setup

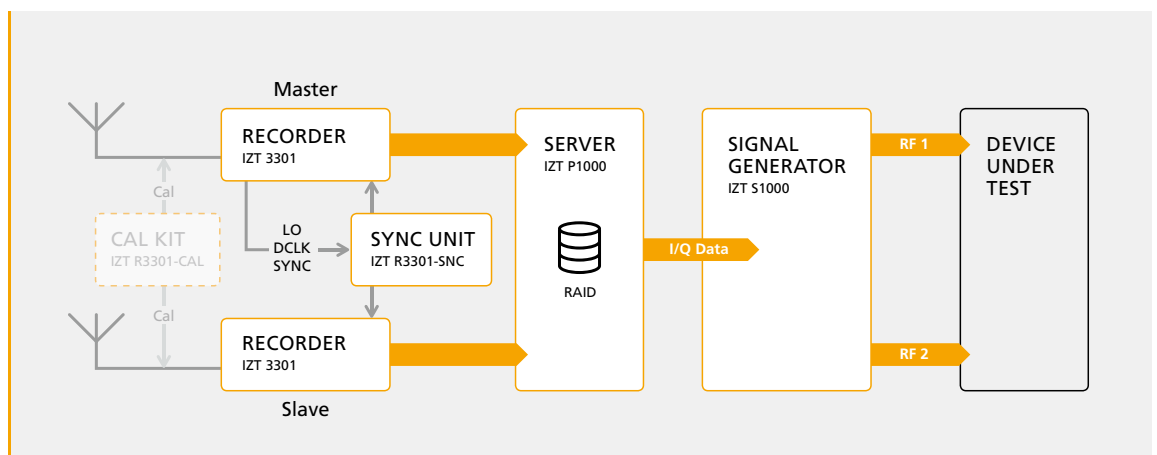

figure 2: IZT RecPlay two channel system setup for diversity and multi-frequency scenarios

## Applications

The RF recorder is suitable for recording typical receive scenarios in different countries with excellent signal quality. The recordings can be stored in a library for functional testing of receivers. It is possible to record and replay signals of up to eight antennas.

The recorder covers the frequency range from 9 kHz to 3 GHz (optional 6 GHz / 18 GHz) with a realtime bandwidth selectable up to 24 MHz, which is sufficient to cover the whole FM broadcast band simultaneously. The replay generator covers the frequency range from 9 kHz to 3 GHz with a bandwidth of 120 MHz, which allows to combine different recorded and calculated scenarios inside this bandwidth.

The IZT RecPlay System consists of three components: a recording system, a server with software for off-line editing and signal sources to replay the signals.

Benefits include greatly reduced costs for field testing, repeatable tests in the lab and fidelity in reproducing real RF environment which allows a shorter time to market.

The record and replay system IZT RecPlay is the ideal platform for RF receiver design validation of analog and digital radio, video and Global Navigation Satellite Systems (GNSS) for developing and testing automotive car infotainment systems and chipset.

## RecPlay System

The IZT RecPlay record and replay system consists of at least one IZT R3301 RF Recorder with integrated high performance RF receiver and built-in server, an external server for data streaming and one IZT S1000 signal generator for replay of the recorded I/Q data (figure 1).

An IZT RecPlay system for diversity recording consists of one IZT R3301 RF Recorder per

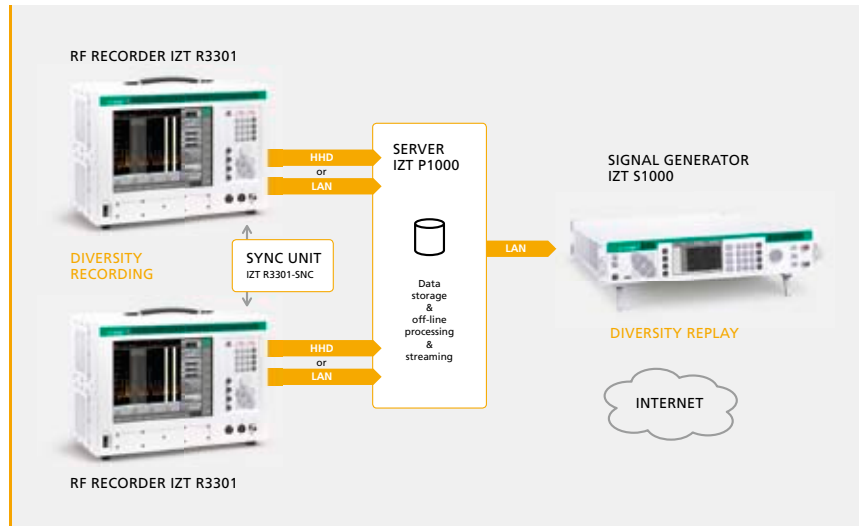

**figure 3:** IZT RecPlay diversity setup with streaming server for data post processing

antenna and is synchronized by an external clock distribution (figure 2).

A common reference clock alone (f.e. 10 MHz) will not be sufficient to ensure all receivers operate phase synchronous. Therefore, one master IZT R3301 creates all necessary clock signals, like system clock and both VHF-UHF local oscillators, and sends them to a central clock distribution, which amplifies the signals and passes them on to all receivers. An additional trigger impulse starts the sample-synchronous recording of the system. Intercommunication between master and slaves of the built-in servers is controlled via optical LAN interface to minimize EMI. The built-in GPS receiver of the master serves as time and location reference.

If necessary, a calibration signal can be coupled into the antenna feeds, which allows to establish zero phase shift between the antenna inputs.

The captured data streams of up to approximately 115 MByte/sec are sent via internal Gigabit Ethernet to each built in server and is stored on an integrated RAID system.

Figure 3 shows the block diagram of the recording system configured for two diversity signals. The system is modular and can be expanded up to eight antenna signals.



## Recording System

### IZT R3301

The IZT R3301 RF Recorder is a portable receiver with built-in server for data recording. It is optimized for recording RF signals in mobile and portable applications.

The outstanding RF performance and signal processing matches the professional IZT R3000 receiver series. These receivers were developed for applications of regulatory agencies, military and civilian radio surveillance and as lab test equipment. They are designed to produce good signal quality under extreme dynamic range and have successfully passed many rigorous technical evaluations with civilian and military customers.

With its very high dynamic range (figure 4) and excellent phase noise this receiver platform is the ideal solution for the needs of modern digital modulation standards.

Thanks to its front panel control, touch screen and integrated processing hardware, the IZT R3301 RF Recorder is the perfect portable RF recording system. While having a compact and rugged design, it also meets CISPR 25 / EN 55025 for extremely low RF emissions. The wide range AC and DC power supply is completed by an uninterrupted power supply (UPS) for surge & sub voltage protection against DC supply fluctuations. An internal GPS module adds location information to the received signals.

The IZT R3301 is characterized as follows:

- Portable, rugged design: 45 x 35 x 24 cm, approx. 17 kg
- Continuous I/Q data recording with up to 30 MSamples/s
- Swappable RAID system (figure 5) for about 6 hours of continuous recording with 24 MSamples/s in 2 TB configuration
- Built-in GPS for embedded location information
- 10 to 30V DC power supply, approx. 150 W

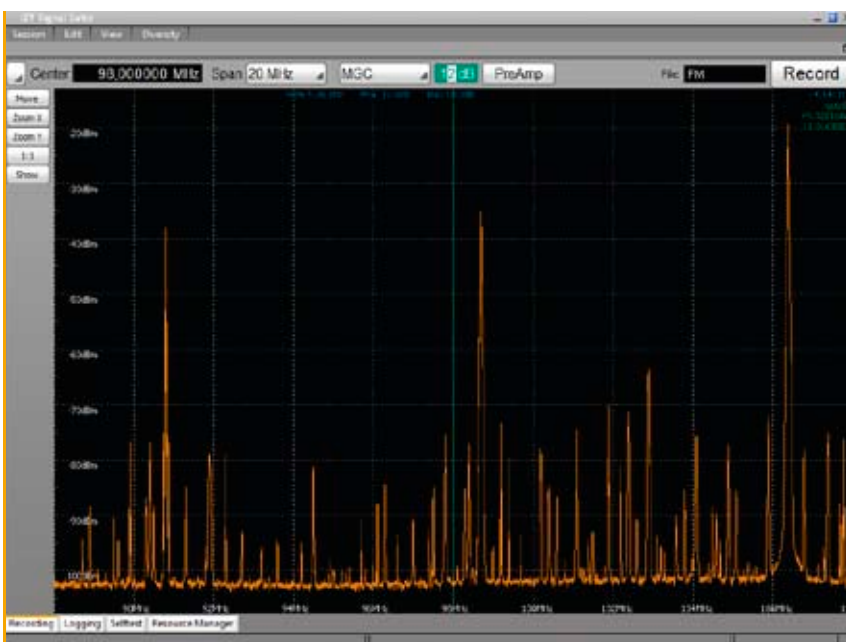

figure 4: FM broadcast recording with high dynamic range

- 100 to 240V AC supply with built-in UPS
- Control via touch screen
- Synchronization interface for diversity and multi-frequency recording (figure 7)
- Low RF emissions, meets EN 55025 / CISPR 25
- Built-in high-end IZT R3000 receiver technology

The outstanding RF performance of the integrated IZT R3000 receiver technology is based on a very modern and market proven receive system with excellent reception at very good signal quality. It is highly insensitive to strong adjacent band interference due to sub-octave preselector filters and high first intermediate frequency.

The integrated IZT R3000 receiver is characterized as follows:

- 9 kHz to 3 GHz frequency range
- Real-time bandwidth up to 24 MHz
- Very low phase noise
- High linear RF frontend for excellent IP3 performance
- Preselector filter-bank guarantees best IP2 performance
- Additional digital filtering
- IF Filter bandwidth: 6.25 kHz to 24 MHz
- 1 Hz tuning resolution
- Multichannel recording of up to 4 different bandwidths simultaneously

An external synchronization unit (figure 6) provides phase coherent clock to multiple IZT R3301 RF recorders in diversity or multi-frequency setups. It can be enhanced by a calibrated signal source (connected directly to the junction plane of the antenna connectors) in test scenarios where absolute phase difference between the antennas is needed (figure 3).

Remote connection between multiple recorder units is made via optical LAN interface to prevent electromagnetic interference. An optical LAN converter allows for complete remote control of a single IZT R3301 unit over longer distances without EMI problems, for example in a highly sensitive RF measurement setup inside an EMI chamber.



figure 5: Easy RAID storage swapping



figure 6: Synchronization unit



figure 7: External interfaces for power supply, LAN, GPS antenna and synchronization

**Application Example 1:  
Diversity antenna setup**

The system is ideal for handling phase coherent and frame synchronous recordings with multiple antennas at the same center frequency, e.g. for validation of FM broadcast diversity-tuners. This challenging use case requires a very high accuracy in signal and data processing of the record and replay system.

**Application Example 2:  
Multi-frequency antenna setup**

The system also fits perfectly into handling frame synchronous recording with multiple antenna channels at different center frequencies. This is an important use case for automotive customers for testing seamless DAB to FM linking in the field. The setup allows also to record DAB and DVB or the GPS satellite signal and any other service at the same time.

Of course application example 1 and 2 can be combined for covering both a phase coherent FM broadcast diversity and also frame synchronous DAB recording by using a IZT RecPlay setup consisting of three synchronized RF recorders IZT R3301.



## Replay System

### IZT S1000 Multichannel Signal Generator

Replay of the RF signals is done with signal generator IZT S1000. Contrary to most signal generators available today, the IZT S1000 has been specifically designed to replay complex signals comprising a large number of individual carriers.

The IZT S1000 is characterized as follows:

- 9 kHz to 3 GHz frequency range
- 120 MHz bandwidth
- 31 virtual signal generators (independent VSG channels)
- Dual RF outputs support diversity replay for two antennas
- Phase synchronous replay of diversity signals
- Continuous streaming up to 2 x 24 MSamples/s data from external server
- Real-time impairment simulation
- Modulators for DAB, DAB+, DMB, XM, Sirius, HDRadio
- Universal ARB function with up to 8 GB RAM
- Easy to use compact setup

Figure 8 shows a setup for playing two diversity signals with a maximum bandwidth of 120 MHz. The setup can be expanded easily to a system with four or up to eight diversity replay channels by combining multiple external synchronized IZT S1000 signal generators.

For diversity or multi-frequency streaming bandwidth is divided into 2 x 24 MSamples/s allowing to stream two independent signals with 20.5 MHz bandwidth each (figure 9).

As this IQ data stream is handled dynamically with up to 48 MSamples/s by using LAN load balancing techniques, multiple channels with individual bandwidth can be streamed simultaneously (figure 11).

Additional signals can be generated at the same time from the internal 8 GB IZT S1000 memory. An optional calibration kit can be used to preserve the absolute phase difference between the two antennas of the diversity recording setup up to the DUT inputs (figure 9).

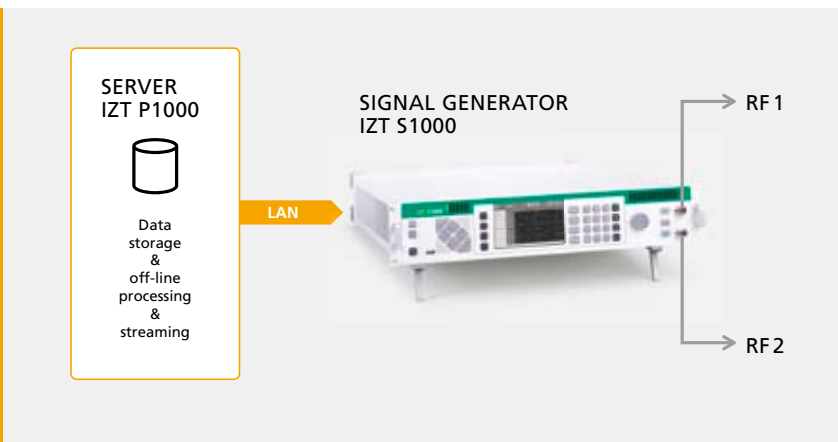

figure 8: Player for diversity signals, using a single IZT S1000 with two rf outputs

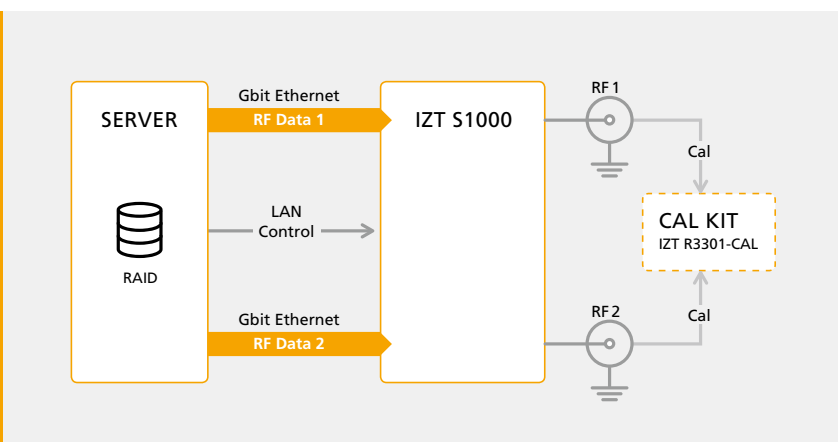

figure 9: IZT S1000 data & control interface for 2 x 24 MSamples/s streaming



figure 10: IZT S1000 replay setup with P1200 streaming server and real-time GPS map visualization

	Signal 1	Signal 2	Signal 3	Signal 4	Signal 5
Program	12F 80000	12F 80000	12F 80000	12F 80000	12F 80000
Channel	signal_2_35-Tone_2_40Mhz_31224-00	signal_2_104-Tone_200-GHz_31224-0	signal_2_35-Tone_200-GHz_31224-00	signal_2_102-Tone_1-80Mhz_31229-00	for_HQI_master_281042_02142-00001
Sampling Rate	2000000.000000 Hz	300000.000000 Hz	300000.000000 Hz	2500000.000000 Hz	28300000.000000 Hz
Duration	0 sec	0 sec	0 sec	0 sec	0 sec
Mode	On	On	On	Off	Off
Source	Max8814k	Max8814k	Max8814k	Max8814k	Max8814k
Delay	0.000 sec	0.000 sec	0.000 sec	0.000 sec	0.000 sec
Channel Type	QAM	QAM	QAM	QAM	QAM
Modem	QPS	QPS	QPS	QPS	QPS
Frequency	97.300000 MHz	94.700000 MHz	94.700000 MHz	102.300000 MHz	97.300000 MHz
Gain Control	Auto	Auto	Auto	Auto	Auto
Power	134.0 dBm	134.0 dBm	134.0 dBm	134.0 dBm	134.0 dBm
Gain	0.0 dB	0.0 dB	-40.0 dB	0.0 dB	0.0 dB
1% Bandwidth	0.00000 Hz	0.00000 Hz	0.00000 Hz	0.00000 Hz	0.00000 Hz
CR	1.0 dB	1.0 dB	1.0 dB	1.0 dB	1.0 dB
CR	0.0 dB	0.0 dB	0.0 dB	0.0 dB	0.0 dB

figure 11: IZT S1000 GUI streaming multiple VSG signals with variable bandwidths at individual center frequencies and power levels

### IZT S1000-MTX Switching Matrix



The IZT S1000-MTX is an external 2:4 RF switch matrix for the IZT S1000 signal generator. It can be used for test setups in DUT environment and laboratory. The IZT S1000-MTX is capable of simulating Bias-T current sinks, e.g. for active antennas. RF Filters can be looped-in at each single RF output. The switching behaviour is controlled from the IZT S1000 GUI and can also be controlled via remote interface.

## IZT Signal Suite Data Processor

The IZT Signal Suite RecPlay Data Processor is a powerful unique data processing software which allows to review and to edit recorded data in off-line mode:

- Fast interactive display of spectrum and spectrogram
- Display of meta data information, e.g. recorder settings, GPS location information.

The IZT Signal Suite RecPlay Data Processor can be used to extract or combine individual signals from a recording which means easy to use cut, copy, paste & merge functionality of RF signals in time and frequency domain:

- Extraction of time segments of a recording
- Extraction of signals in spectrogram (time and frequency) and conversion of the signal into a player file with adequate sample rate (figure 13)
- Deletion of individual signals from a wide-band spectrum (figure 14)
- Concatenation of recordings in time domain
- Concatenation of recordings in the frequency domain

Moreover this concatenation of single recordings in the frequency domain allows to record frequency bands wider than 20.5 MHz (e.g. DVB-T) in several adjacent frequency intervals and combine these recordings to a single file with large bandwidth of up to 120 MHz to replay it with IZT S1000 signal generator platform.

Several additional plug-in interfaces are available for the IZT Signal Suite RecPlay Data Processor:

- Map visualization interface for embedded GPS streaming data (figure 12)
- Video/audio camera replay function
- Encryption interface for key based IZT S1000 streaming

- RDS demodulator
- Database client for easy data synchronization with IZT RecPlay Database
- Direct streaming with Data Processor

The post processing software includes an export function for Avera (NI) and R&S I/Q compatible data formats and plain I/Q data. Other data formats can be supported on request.

For both off-line post-processing and multi-channel I/Q data streaming, IZT provides several server solutions with specially selected components for efficiently handling the sophisticated algorithms of the IZT Signal Suite RecPlay Data Processor with optimum performance.

- Cost effective signal streaming server IZT P1100
- Powerful off-line data processing and signal streaming server IZT P1200, including 2.5" tray for easy data storage swapping (figure 10)
- High performance data storage server IZT P1300 for IZT RecPlay Database, also suitable for powerful off-line data processing and signal streaming, including 2.5" tray for easy data storage swapping



figure 12: Off-line visualization of GPS location information

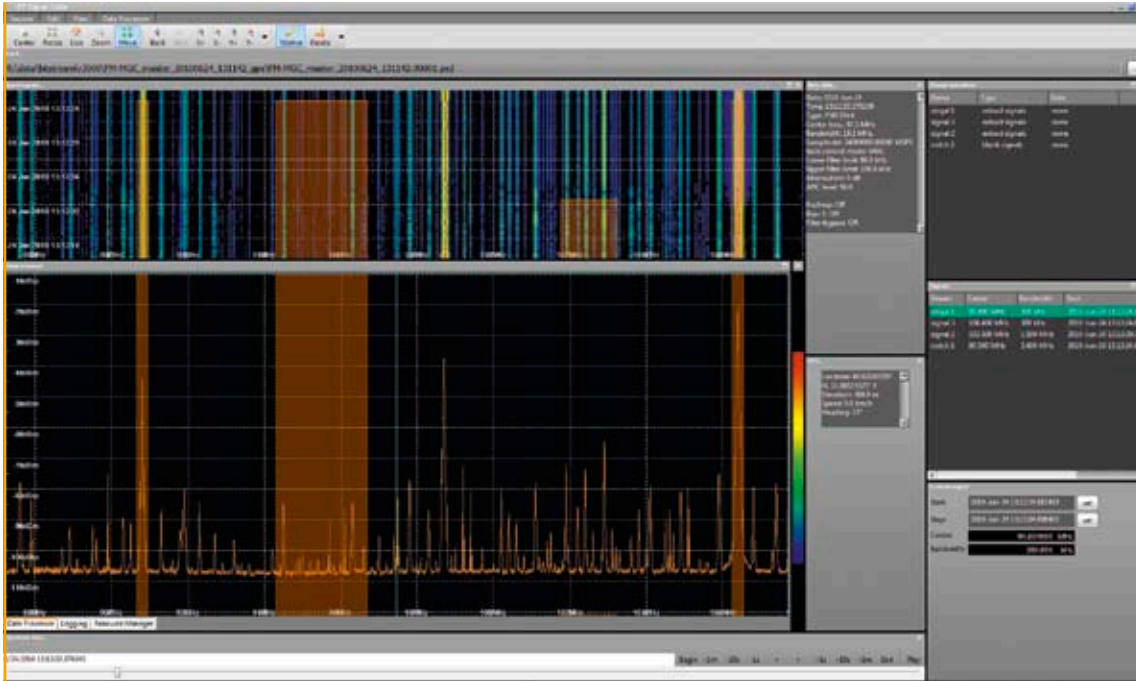

figure 13: Extracting multiple signals simultaneously with individual timeline, bandwidths and centerfrequencies

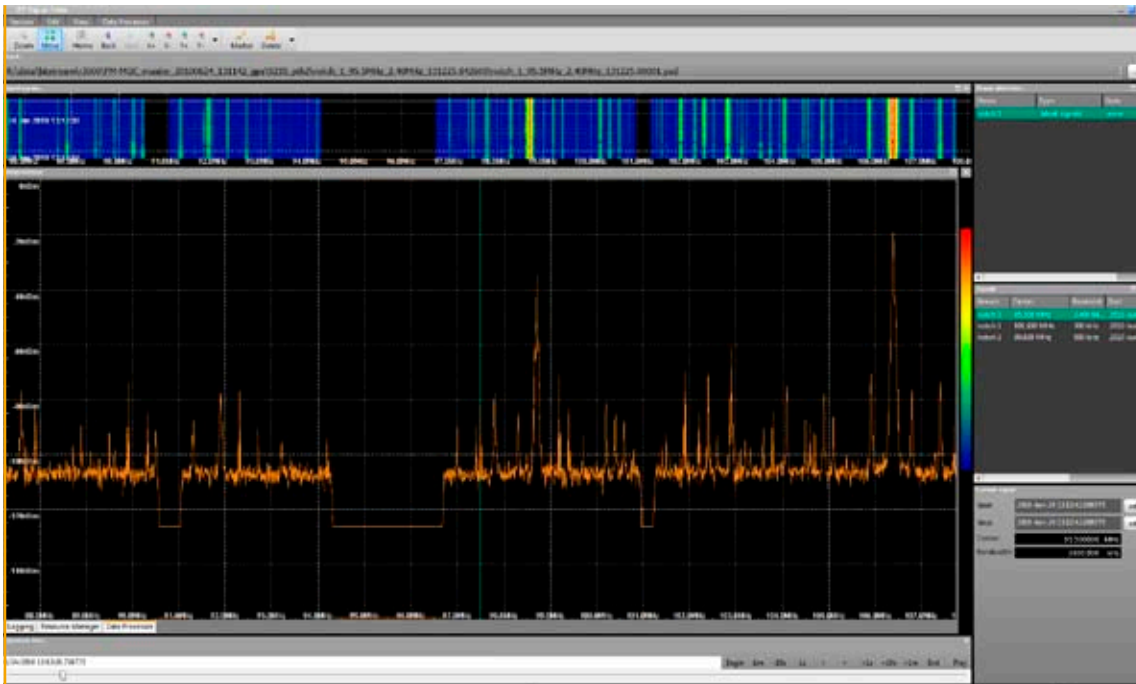

figure 14: Blanking multiple signals with individual bandwidths and centerfrequencies of a wideband FM broadcast recording

## Technical Specifications – IZT R3301 RF Recorder

RF characteristics		
<b>Frequency range</b>		9 kHz to 3 GHz
<b>Conversion concept</b>	9 kHz to 30 MHz <sup>1)</sup> (HF)	Direct sampling
	20 MHz to 3 GHz <sup>2)</sup> (VUHF)	Double superheterodyne conversion
<b>RF input</b>	Impedance	50 Ohm
<b>Maximum input power</b>	HF	+20 dBm, +30 dBm with input attenuator active
	VUHF	+15 dBm
<b>Tuning resolution</b>	HF, VUHF	1 Hz
<b>VSWR</b>	HF, VUHF	< 2.1
<b>Tuning accuracy</b>	HF, VUHF	< 0.2 Hz
<b>Reference frequency</b>	HF, VUHF	10 MHz internal/external
<b>Internal reference stability</b>	HF, VUHF	< 1 x 10 <sup>-7</sup>
<b>Input sensitivity</b>	HF: 100 kHz to 30 MHz @ S/N = 10 dB	-120 dBm @ 3 kHz BW -111 dBm @ 25 kHz BW
	VUHF: 20 MHz to 3 GHz @ S/N = 10 dB	-114 dBm @ 3 kHz BW -105 dBm @ 25 kHz BW -92 dBm @ 500 kHz BW
<b>Oscillator phase noise</b>	HF	-130 dBc/Hz typical @ 1 kHz offset -140 dBc/Hz typical @ 10 kHz offset
	VUHF	-120 dBc/Hz typical @ 10 kHz offset
<b>Sweep time</b>	HF, VUHF	< 3 ms
<b>Scanning speed</b>	HF, VUHF	> 4 GHz/s, linear
		> 175 GHz/s, within 24 MHz bandwidth
<b>Input IP3</b>	HF	+40 dBm typical
	VUHF	+24 dBm, typical (Low Distortion Mode) +13 dBm, typical (Normal Mode)
<b>Noise figure</b>	HF	9 dB typical
	VUHF	10 dB (f < 2 GHz) to 12 dB (f > 2 GHz), typical (Low Noise Mode) 13 dB (f < 2 GHz) to 15 dB (f > 2 GHz), typical (Normal Mode)
<b>IF rejection</b>	HF	not applicable
	VUHF	> 120 dB typical
<b>Image rejection</b>	HF	not applicable
	VUHF	> 110 dB typical
<b>Oscillator reradiation at antenna input</b>	HF	not applicable
	VUHF	< -110 dBm
<b>Preselector</b>	HF	12-Band
	VUHF	11-Band
<b>IF bandwidth</b>	HF, VUHF	6.25 kHz to 24 MHz

<sup>1)</sup> degraded performance: 9 kHz to 500 kHz    <sup>2)</sup> degraded performance: 20 MHz to 30 MHz

Signal generation	
<b>Operating system</b>	Windows 7 Ultimate (64bit)
<b>Integrated hard disk</b>	2.5" SATA system disk 320 GB
<b>Internal memory</b>	8 GB
<b>Data representation</b>	Data format: 16/32 bit I/Q with embedded IZT CBB metadata information
<b>Output sample rate</b>	variable up to 30 MSamples/s
<b>Data storage</b>	4 x 2.5" SATA HDD or SSD, removable tray; 2 TB RAID system by default
<b>Recording modes</b>	stand alone, diversity, multi-frequency
<b>Gain control</b>	AGC fast/slow with adjustable ADC backoff and deadband, MGC

Interfaces		
<b>Antenna input</b>	HF, VUHF	N, female, 50 Ω
<b>Data storage system</b>	SATA tray	4 x 2.5" HDD or SSD, 9.5 mm height, removable
<b>LAN</b>	Gigabit LAN	RJ45, CAT 6
	Gigabit LAN, optical	LC-Duplex
<b>USB</b>	2 x USB 2.0	
<b>GPS antenna</b>	Input	SMA, female, 50 Ohm
	Active biasing	< 60 mA @ 3 V DC
<b>Synchronization</b>	Input	3 x SMA, female, 50 Ω (DCLK, 2x VUHF LO)
	Output	3 x SMA, female, 50 Ω (DCLK, 2x VUHF LO)
<b>Trigger pulse</b>	Input	SMA, female, CMOS 3.3 V (5 V tolerant input)
	Output	SMA, female, CMOS 3.3 V
<b>Reference input</b>	10 MHz	SMA, female, 50 Ω
<b>Remote control</b>	D-SUB 9, female	

General data	
<b>Operating temperature</b>	0° to +40°C
<b>Storage temperature</b>	-20°C to +60°C
<b>Humidity</b>	max. 85%, non-condensing
<b>EMI / EMC</b>	CISPR 22 / CISPR 25 (EN 55022 / EN 55025)
<b>MTBF</b>	> 10.000 hrs (MIL-HDBK)
<b>Power supply</b>	AC: 100–240 V, 47–63 Hz, 240 VA, DC: 10–30 V, 150 W
	UPS: Li-Ion, 56,4 Wh; approx. 10 min. recording, 15 min. measurement
<b>Dimensions</b>	450 x 347 x 234 mm (W x D x H)
<b>Weight</b>	approx. 17 kg

Frequency range extension	IZT R3301-RF6	IZT R3301-RF18
<b>Frequency range</b>	3 GHz to 6 GHz	3 GHz to 18 GHz
<b>RF input</b>	50 Ohm	50 Ohm
<b>Maximum input power</b>	+15 dBm	+10 dBm
<b>VSWR</b>	< 2.1	< 2.1
<b>Oscillator phase noise</b>	-120 dBc/Hz typical @ 10 kHz offset	-114 dBc/Hz typical @ 10 kHz offset
<b>Sweep time</b>	< 3ms	< 3ms
<b>Scanning speed HF, VUHF</b>	> 4 GHz/s, linear	> 4 GHz/s, linear
	> 175 GHz/s, within 24 MHz bandwidth	> 175 GHz/s, within 24 MHz bandwidth
<b>Input IP3</b>	+18 dBm (Normal Mode)	+25 dBm (Low Distortion Mode)
	+2 dBm (Low Noise Mode)	
<b>Noise figure</b>	6 dB, typical (Low Noise Mode, LNA on, maximum gain)	15 dB (Low Noise Mode)
	16 dB, typical (Normal Mode, LNA off, maximum gain)	
<b>IF rejection</b>	> 120 dB typical	> 120 dB typical
<b>Image rejection</b>	> 110 dB typical	> 110 dB typical
<b>Oscillator reradiation</b>	< -110 dBm	< -120 dBm
<b>Preselector filter</b>	8-Band	Tracking bandpass filter

Specification subject to change without further notice.

## Technical Specifications – IZT S1000 Signal Generator

RF characteristics		
<b>Frequency</b>	Range	9 kHz to 3 GHz
	Resolution	0.001 Hz
<b>Instantaneous bandwidth</b>	9 kHz to 30 MHz	30 MHz
	90 MHz to 2940 MHz	120 MHz
<b>Reference</b>	Accuracy	OEXO
	Aging	$\pm 5 \cdot 10^{-8}$ per year
	Temperature stability	$< \pm 1 \cdot 10^{-8}$
	Warm-up time	10 min
<b>Power level</b>	Maximum output power	+20 dBm, typical
	Resolution	0.1 dB
	Uncertainty	$\pm 0.5$ dB from +10dBm to -50dBm; $\pm 1.0$ dB below -50dBm
<b>Spectral purity</b>	Harmonics	$< -30$ dBc at +10 dBm
	SSB phase noise non harmonics	$< -70$ dBc, typical

Signal generation		
<b>Integrated hard disk</b>	Size	320 GB
<b>Internal memory</b>	Size	4 GB, 8 GB (optional)
<b>External LAN</b>	Connection	2 x 1000 BaseT UDP/TCP
<b>Channels</b>	Number of	up to 31
<b>Data representation</b>	Data format	12/16 bit I / Q
	Input sample rate	variable up to 40 MSamples/s

General data		
<b>Power supply, nominal values</b>	Input voltage range: 100 V to 240 V (AC)	
	AC supply frequency: 50 Hz to 60 Hz	
	Max. input current: 1.4 A (100 V) to 0.6 A (240 V)	
<b>EMC</b>	Meets EN 55022, class B, QP, AV	
<b>Environmental conditions</b>	Operating temperature: 0°C to 55°C	
	Storage temperature: -40°C to +70°C	
<b>Dimensions</b>	19", 2 U, depth 570 mm	
<b>Weight</b>	$< 12$ kg	
<b>Recommended calibration interval</b>	2 years	

Switching Matrix	IZT S1000-MTX	
<b>Frequency range</b>	RF IN/OUT	100 kHz to 3000 MHz
<b>RF inputs/outputs</b>	RF IN/OUT	SMA, female, 50 $\Omega$
<b>Maximum input level</b>	RF IN 1,2	+10 dBm
	RF OUT 1-4	16V DC / 100 mA
<b>VSWR (input/output)</b>	RF IN 1,2	$< 1.6:1$
	RF OUT 1-4	$< 1.6:1$ (typ. $< 1.25:1$ @ 1 GHz, $< 1.35:1$ @ 2 GHz)
<b>Insertion loss</b>	$< 4$ dB (typ. 1 dB @ 1 GHz, 2.5 dB @ 2 GHz)	
<b>DC input</b>	S1000 GPIO	$V_{\text{SUPPLY}} = 11$ to 13 V
	RF OUT 1-4	$V_{\text{BIAS}} = 6$ to 15 V, IBIAS = 0 to 95 mA
<b>Dimensions</b>	443 x 430 x 41.6 mm (W x D x H)	

Specification subject to change without further notice.

## Technical Specifications – IZT P1000 Streaming Server

System specification	IZT P1100	IZT P1200	IZT P1300
<b>Operating system</b>	Windows 7 Ultimate (64 bit) or Open SuSE 11.1 (64 bit)	Windows 7 Ultimate (64 bit)	Windows 7 Ultimate (64 bit)
<b>CPU</b>	AMD Athlon II X265	Intel Core I7-960	Intel Core I7-960
<b>Internal memory</b>	8 GB	12 GB	12 GB
<b>Internal system hard disk</b>	250 GB	320 GB	320 GB
<b>Internal data storage</b>	2 x 4 TB Raid0 System	2 x 6 TB Raid0 System	1 x 4 TB Raid0 System
			1 x 14 TB Raid5 System
		2 x 2.5" SATA tray (1 TB)	4 x 2.5" SATA tray (2 TB)
<b>Optical</b>	DVD-ROM		
<b>External LAN</b>	4 x Gbit High Speed	4 x Gbit High Speed	4 x Gbit High Speed
<b>Graphical interface</b>		NVIDIA GTS 250	NVIDIA GTS 250
<b>Display</b>	17" TFT	24" TFT	24" TFT
<b>Interfaces</b>	2 x ESATA (Raidcontroller)	2 x ESATA	2 x ESATA
	8 x USB2.0	2 x USB 3.0	2 x USB 3.0
		4 x USB 2.0	4 x USB 2.0
		2 x IEEE 1394	2 x IEEE 1394
<b>Input</b>	USB Keyboard, USB Mouse	USB Keyboard, USB Mouse	USB Keyboard, USB Mouse
<b>Width</b>	426 mm (+52 mm incl. ears)	426 mm (+52 mm incl. ears)	426 mm (+52 mm incl. ears)
<b>Depth</b>	510 mm (+20 mm incl. grips)	510 mm (+20 mm incl. grips)	510 mm (+20 mm incl. grips)
<b>Height</b>	133 mm	178 mm	178 mm
<b>Weight</b>	17kg	25,6 kg	28,0 kg

Environmental specifications	
<b>Operating temperature</b>	0°C to 50°C
<b>Storage temperature</b>	-40°C to 70°C
<b>Operating humidity</b>	5% to 95% non-condensing
<b>Storage humidity</b>	5% to 99% non-condensing
<b>Operating altitude range</b>	2000 m

Specification subject to change without further notice.

## Ordering Guide

### IZT R3301 RF Recorder *Hardware options*

<b>IZT R3301</b>	IZT R3301 RF Recorder
<b>IZT R3301-RF6</b>	Frequency Range Extension 3 GHz to 6 GHz
<b>IZT R3301-RF18</b>	Frequency Range Extension 3 GHz to 18 GHz
<b>IZT R3301-BST</b>	Bias-T
<b>IZT R3301-OCX</b>	Oven Stabilized Reference Oscillator
<b>IZT R3301-TCS</b>	IZT R3301 Transport Case
<b>IZT R3301-KBD</b>	USB Keyboard w. Touchpad
<b>IZT R3301-SNC</b>	Synchronization Kit for two recording units
<b>IZT R3301-CAL</b>	Calibration Kit for two recording units
<b>IZT R3301-SNC6</b>	Synchronization Kit for six recording units
<b>IZT R3301-CAL6</b>	Calibration Kit for six recording units
<b>IZT R3301-OLC</b>	Ethernet Converter Kit
<b>IZT R3301-SSD</b>	Solid State System Disk
<b>IZT R3301-SDD</b>	Solid State Data Disk
<b>IZT R3301-CAM</b>	IP Camera Kit
<b>IZT R3301-LFM</b>	Low Noise Amplifier FM
<b>IZT R3301-LDV</b>	Low Noise Amplifier DAB III
<b>IZT R3301-LDL</b>	Low Noise Amplifier DAB L
<b>IZT R3301-GPA</b>	GPS Amplifier
<b>IZT R3301-TCA</b>	Transport Case for IZT R3301 Accessories

### IZT S1000 Signal Generator *Hardware options*

<b>IZT S1000-CHS</b>	IZT S1000 Chassis including GUI
<b>IZT S1000-RF3</b>	RF Output 3GHz
<b>IZT S1000-RFS3</b>	RF Synthesizer 3GHz
<b>IZT S1000-8GB</b>	8 GB High Speed Memory
<b>IZT S1000-ESATA</b>	ESATA Interface
<b>IZT S1000-CAL</b>	Calibration Kit
<b>IZT S1000-MTX</b>	RF Switching Matrix

### *Software options*

<b>IZT S1000-110</b>	VSG channel (up to 31)
<b>IZT S1000-120</b>	Streaming input
<b>IZT S1000-301</b>	Phase Noise Simulation
<b>IZT S1000-302</b>	Nonlinearity Simulation and TX Output-Filter Simulation
<b>IZT S1000-304</b>	Fading Channel Simulator with fixed Delays
<b>IZT S1000-305</b>	Power Level Profiles
<b>IZT S1000-306</b>	Frequency / Delay Profiles / Moving Path for Fading Channel Simulation
<b>IZT S1000-307</b>	Shaped Noise

<b>IZT P1000 Server</b>	<b>IZT P1100-SRV</b>	IZT P1100 Streaming Server (Monitor and Keyboard/Mouse included)
	<b>IZT P1200-SRV</b>	IZT P1200 Diversity & Data Processing Server (Monitor and Keyboard/Mouse included)
	<b>IZT P1300-SRV</b>	IZT P1300 Database & Data Processing Server (Monitor and Keyboard/Mouse included)
	<b>IZT P1000-RCK</b>	Rack for IZT Server
<b>RecPlay Options</b>	<b>IZT RecPlay-100</b>	IZT Signal Suite RecPlay Data Processor
	<b>IZT RecPlay-105</b>	Database Client
	<b>IZT RecPlay-106</b>	Streaming Interface
	<b>IZT RecPlay-107</b>	Encryption Interface
	<b>IZT RecPlay-108</b>	IP Camera Interface
	<b>IZT RecPlay-110</b>	GPS map visualization
	<b>IZT RecPlay-111</b>	Map conversion (per package)
	<b>IZT RecPlay-120</b>	RDS demodulator
	<b>IZT RecPlay-121</b>	RDS demodulator enhancement
	<b>IZT RecPlay-200</b>	IZT Signal Suite Database
	<b>IZT RecPlay-300</b>	IZT Signal Suite RecPlay Recorder
	<b>IZT RecPlay-400</b>	IZT Signal Suite Multichannel-Diversity Controller (Notebook not included)
	<b>Service</b>	<b>IZT WE2</b>
<b>IZT WE3</b>		Warranty Extension to 3 years
<b>IZT RecPlay-TRC</b>		IZT RecPlay Training Course
<b>IZT R3301-CLC</b>		Calibration
<b>IZT S1000-CLC</b>		Calibration

# IZT RecPlay

## Record & Replay System for RF Signals

### Innovationszentrum für Telekommunikationstechnik GmbH IZT

General Manager: Rainer Perthold  
Am Weichselgarten 5, D-91058 Erlangen, Germany  
Phone: +49 (0)9131 4800-100 Fax:-190  
sales@izt-labs.de www.izt-labs.de

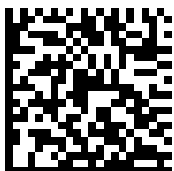

### About IZT

The Innovationszentrum fuer Telekommunikationstechnik GmbH IZT specializes in the most advanced digital signal processing and field programmable gate array (FPGA) designs in combination with high frequency and microwave technology.

The product portfolio includes equipment for signal generation, receivers for signal monitoring and recording, transmitters for digital broadcast, digital radio systems, and channel simulators. IZT offers powerful platforms and customized solutions for high signal bandwidth and real-time signal processing applications. The product and project business is managed from the principal office located in Erlangen/Germany.

IZT distributes its products worldwide together with its international strategic partners. Customers are public and private companies, governmental agencies and armed forces.

The IZT quality management system is ISO 9001:2000 certified.